



POLYMER PRODUCTS

Wide assortment of polymer products



The special material composition and state-of-the-art manufacturing technologies provide the ACO polymer concrete with its outstanding quality:

- Smooth and hygienic surfaces, low joint content
- Suitable for heavy mechanical loads
- Very high dimensional accuracy
- Long lifetime



POLYMER CONCRETE PRODUCTION

ACO FUNKI offers a great assortment of polymer concrete products. We offer troughs for pigs and cattle, special troughs, feed tables, slurry plugs as well as drainage systems and heating plates.



The products are being produced at ACO's own production facilities in Germany in order to ensure the best quality and durability.

POLYMER CONCRETE AS MATERIAL

The special material composition and state-of-the-art manufacturing technologies provide the ACO polymer concrete with its outstanding quality.

- Smooth and hygienic surfaces, low joint content.
- Suitable for heavy mechanical loads.
- Very high dimensional accuracy.

ACO FUNKI troughs have an optimized shaping adapted to the feed intake behavior.

ADVANTAGES:

- Suitable for mechanical stress
- Acid resistant
- Easy to clean
- Suitable for all types of stables
- Animal-friendly design





TROUGHS FOR PIGS

SINGLE TROUGH FOR BOARS AND SOWS

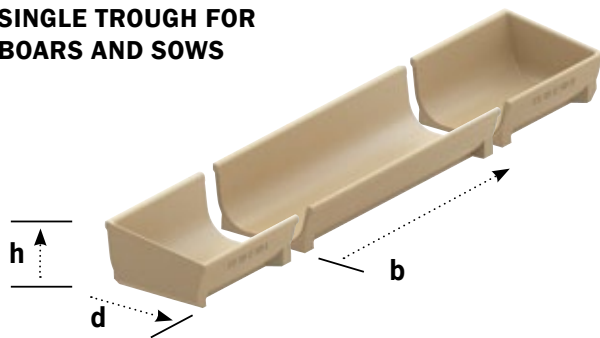

- Material thickness: 2 cm
- The end gables are available for all troughs

Double trough TS 47

- For finishers
- 18 x 53 x 100 cm (h x d x b)
- Weight: 29,5 kg
- Article nr. 01585



Double trough TS 41

- For finishers
- 18 x 46 x 100 cm (h x d x b)
- Weight: 28,7 kg
- Article nr. 03191



Trough TS 28 V

- For gluing
- For finishers
- 15/22 x 30 x 100 cm (h x d x b)
- Weight: 36,5 kg
- Article nr. 18444



Double trough TS 50

- For finishers
- 18 x 58 x 100 cm (h x d x b)
- Weight: 34,5 kg
- Article nr. 02101



Trough TS 36

- For finishers
- 18/30 x 41 x 100 cm (h x d x b)
- Weight: 34,5 kg
- Article nr. 02571



Trough TS 35

- For finishers
- 16,8/21,8 x 39 x 100 cm (h x d x b)
- Weight: 28,3 kg
- Article nr. 01667





PIG TROUGHS - TYPE TS

■ TS30 has been the most preferable trough in Europe for many years. For several reasons: It requires only minimal maintenance. It has a long lifetime and a solid construction. This all adds up to a trough with low maintenance costs.

■ TS30 is designed to give a minimum feed waste. Its animal friendly design combined with its smooth and easy to clean surface all ensures high feed efficiency and hygiene in the stable.

■ TS30 is resistant to acid and bacterial growth because of its solid construction and smooth surface. TS30 troughs are price competitive.

■ TS30 is easy to install due to its simple design, precise fit and flat bottom. The installation requires no special tools.

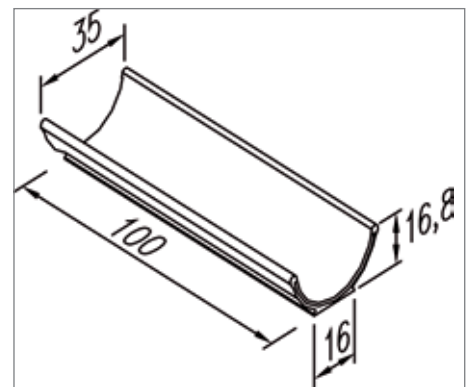
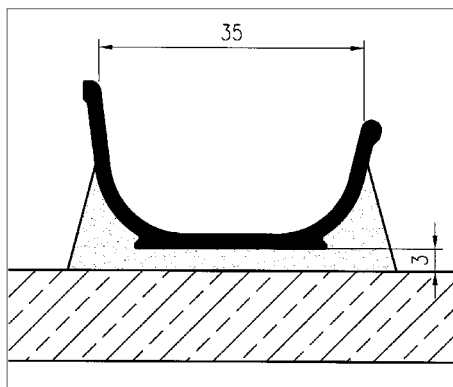
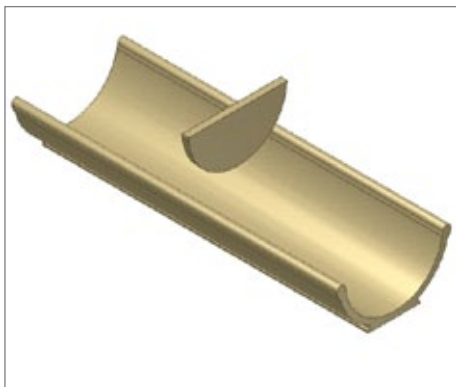

See mounting suggestions on page 12.

PIG TROUGHS

Art. No.	Pig troughs	Length, cm.	Outside width, cm.	Outside height, cm.	Volume, l./m.	Weight each.	Troughs per pallet.
02564	TS 25 1,00 m long	100	30	14,3	22	19	30
02566	Gable end					0,8	100
02850	Partition					0,75	100
18444	TS 28 V 1,00 m long, for glue	100	34	22	30	36,5	20
18445	Partition					1,2	100
01605	TS 30 1,00 m long	100	35	16,8	32	20,1	24
17096	TS 30 E 100 1,00 m long, with gable end	100				20,6	20
17097	TS 30 E 65 0,65 m long, with gable end	65				13,5	20
01664	Partition					0,95	100
01667	TS 35 1,00 m long	100	39	21,8	38	26	16
17081	TS 35 E 50 R 0,50 m long, with gable end R	50				16,6	12
17080	TS 35 E 50 L 0,50 m long, with gable end L	50				16,6	12
01670	Partition					2,1	100
02571	TS 36, 1,00 m long	100	40,8	30	42	31	16
17098	TS 36 E 50 R 0,50 m long, with gable end R	50				18,8	16
17099	TS 36 E 50 L 0,50 m long, with gable end L	50				18,8	16
02605	Partition					1,8	100
03191	TS 41 1,00 m long	100	46	18	50	26,3	22
01595	TS 41 E 100 1,00 m long, with gable end	100				27	20
01596	TS 41 E 65 0,65 m long, with gable end	65				18	20
03204	Partition					1,5	100
01585	TS 47 1,00 m long	100	52	18	55	32	24
01586	TS 47 E 100 1,00 m long, with gable end	100				35	18
01587	TS 47 E 65 0,65 m long, with gable end	65			30	25	18
02101	TS 50 1,00 m long	100	50	18	65	32	12
01600	TS 50 E 100 1,00 m long, with built-in end	100				32	8
01601	TS 50 E 65 0,65 m long, with built-in end	65				25,2	8
554201	105-R 1,20 m long	120	46,2	24,2		68	8
554203	105-RS 1,20 m long, with gable end	120				74	5
554157	110 1,20 m long	120	35	25	33	31	22
554152	110-SV 1,20 m long, with gable end L					29,1	14
554151	110-SH 1,20 m long, with gable end R					29,1	14
554170	Partition					1,3	100
554128	116 1,20 m long	120	57,8	17,8	2x21	45,6	10
554162	Partition						100
	Elevation						
09518	TS 100 1,00 m long	100				9,35	30
09519	TS 65 R 0,65 m long (Requirement: 2 elevations per double trough)	65				6,23	40

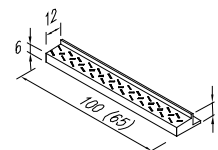
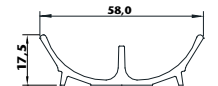
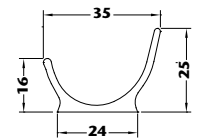
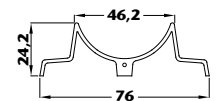
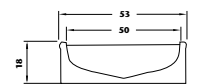
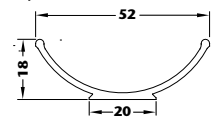
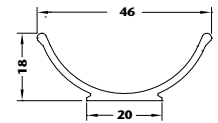
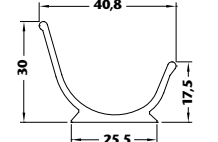
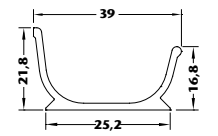
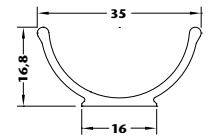
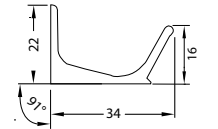
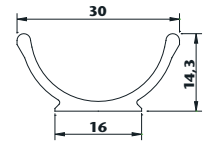



SPECIAL TROUGHS

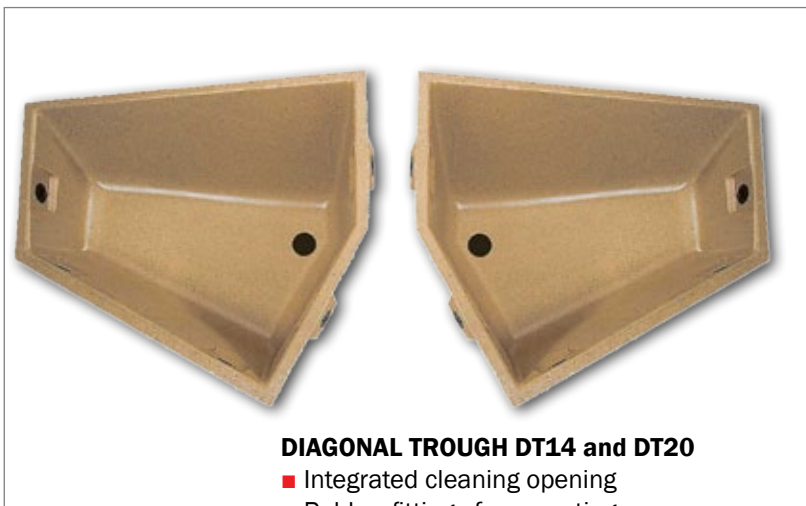

DIAGONAL TROUGH DT14 and DT20

- Integrated cleaning opening
- Rubber fittings for mounting
- Right / Left



TROUGH WITH STEP TS-47



ROUND TROUGH

Available in different sizes



ROUND TROUGH TS R 100

For liquid feeding

SPECIAL TROUGHS

Art. No.	Single trough	Length, cm.	Outside width, cm.	Outside height, cm.	Volume, l./m.	Weight each.	Troughs per pallet.
09550	T 35-50 for encased in concrete	50	38,5	22		19	20
09552	T 35-60 for encased in concrete	60	38,5	22		21,0	20
18333	T 36-49,5 with plug	49,5	38,1	21,8		16,5	20
17297	DT 14 R right, with plug incl. rubber berings for fastening of screws					14,1	20
17298	DT 14 L left, with plug incl. rubber berings for fastening of screws					14,1	20
17299	DT 20 R right, with plug incl. rubber berings for fastening of screws					18,0	20
17300	DT 20 L left, with plug incl. rubber berings for fastening of screws					18,0	20

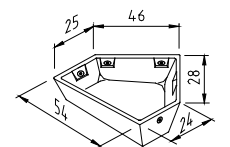
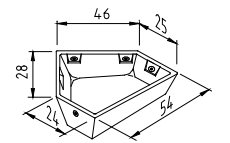
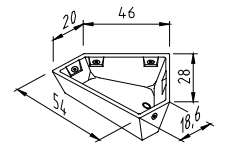
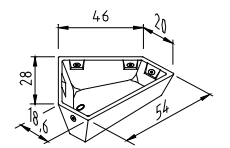
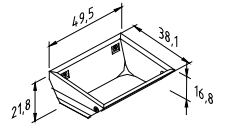
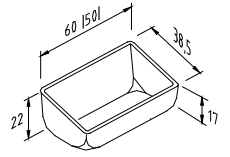

Art. No.	Cups	Length, cm.	Outside width, cm.	Outside height, cm.	Volume, l./m.	Weight each.	Troughs per pallet.
03186	FT 19 Polymer concrete	19	19	8		3,0	48
06906	FTK 27 with inner edge Polymer concrete	27	27	8		5,7	48
554154	326-T (230), Polymer concrete	26	26	6		2,5	56

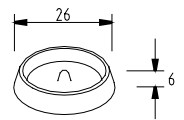
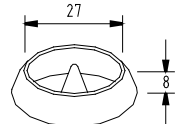
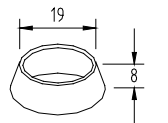



TROUGHS FOR CATTLE

Cattle troughs from ACO FUNKI are adapted to the special physiology of feeding cattle. The troughs are suitable for all feed types and fit for every set-up and support form. They consist of a homogeneous material so their coating is not susceptible to abrasion. The surface is smooth and only needs minimal jointing, which means it is very easy to clean.

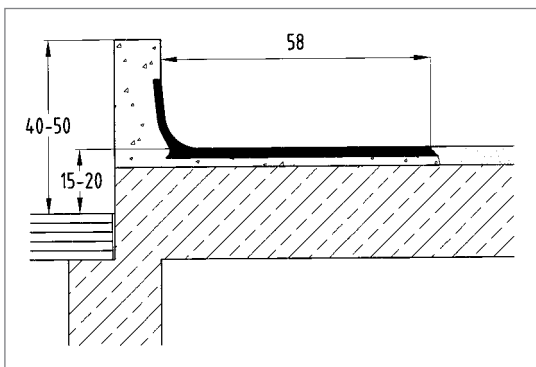
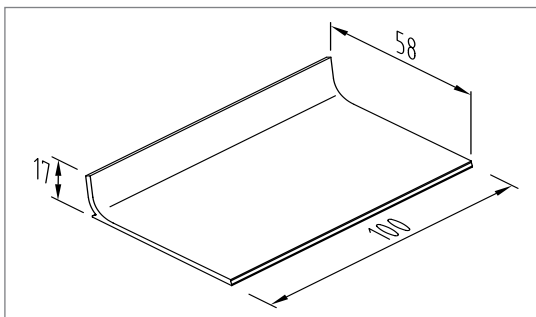

KL60

- The cattle troughs **KL60** are among the preferred troughs in Europe due to their long lifetime, solid construction and low maintenance requirements.
- KL60 is resistant to acids, frost and bacterial growth because of its smooth and easy to clean surface. The homogenous surface is resistant to liquid penetration.
- KL60 ensures a high feed efficiency and hygiene because of its animal friendly design and smooth surface. It provides the cattle with optimum feeding conditions.

See mounting suggestions on page 12.

| CATTLE TROUGHS |

Art. No.	Feed tables	Length, cm.	Outside width, cm.	Outside height, cm.	Volume, l./m.	Weight each.	Troughs per pallet.
09655	KL 60	100	17,0	58,0		30,0	30
17385	KL 70 S	100	6,0	69,0		35,1	25
02326	KL 70	100	17,0	70,0		35,0	20
09693	KL 72	100	27,0	72,0		43,0	18
09657	KL 80	100	22,0	80,0		46,9	20
18268	KL 100	70	27,0	100,0		42,5	14
554135	202	120	14,2	39,6		21,4	30
02080	KM 60	100	14,6	60,0		24,0	24
554150	230/70	120	30	70		55,3	12

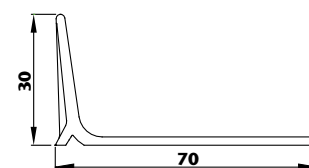
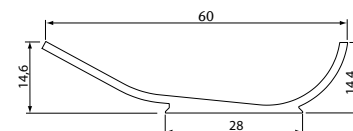
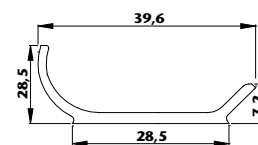
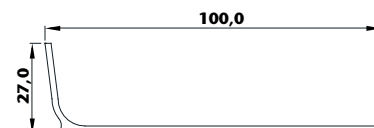
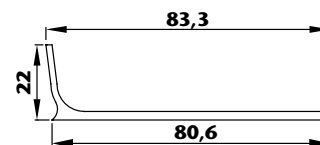
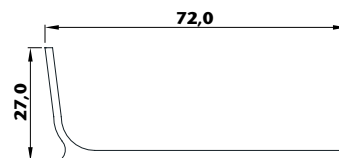
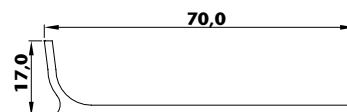
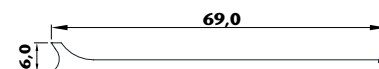
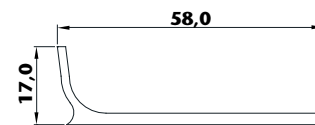



SPECIAL PRODUCTS

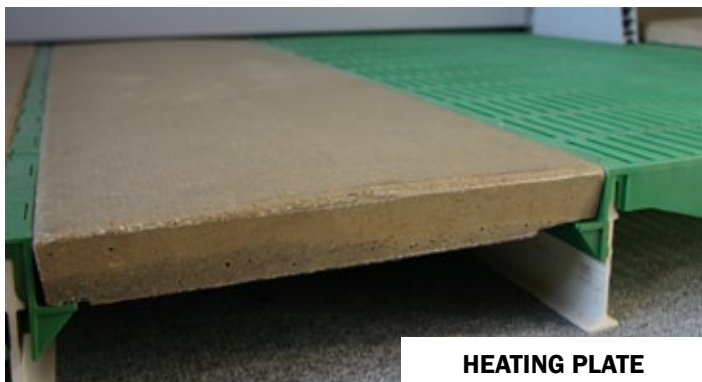

HEATING PLATE

Heating plates are an option in farrowing and weaner pens to provide piglets with optimum comfort and higher survival rate on their first few living days.

THE HEATING PLATE ADVANTAGE:

- Helps to keep temperature constant.
- Provides perfect climate and optimum temperature conditions in the pen.
- Choice of electricity or water heating.
- Good piglet welfare.
- Easy and economical to install.
- Easy to clean.



MANURE PLUGS

With rubber seal and stainless steel bracket. Resistant and sealing.

DRAINAGE SYSTEMS*

The drainage system for yard drainage or for indoor use.



**Contact us for more information about ACO drainage systems.*



COMFORT PLATE

Our comfort polymer plates can replace ordinary concrete tiles in farrowing pens if these have become rough in the surface. Dimensions: 60x40 cm.

| SPECIAL PRODUCTS |

Art. No.	Single trough	Length, cm.	Width, cm.	Voltage, V	Power, W
Art. No. Heating plates - EL					
17582	EL-heating plate	120	40	230	130
18409	EL-heating plate	120	50	230	180
17792	EL-heating plate	120	80	230	180
18855	EL-heating plate	140	50	230	180
Art. No. Heating plates - water					
12630	Water heating plate	140	50	-	240
12631	Water heating plate	120	40	-	240
12633	Water heating plate	120	50	-	120
17813	Water heating plate	120	60	-	160
Art. No. Comfort Plate					
560310	Polymer plate 60x40 cm, complete				
560305	Polymer plate 60x40 cm, without frame				
560300	Frame for polymer plate 20x40 cm, 3 pcs. per plate				
Art. No. Manure plugs					
17334	Manure plug DN150, A: 205 x B: 150 mm				
17016	Manure plug DN200, A: 232 x B: 181 mm				
17161	Manure plug DN250, A: 284 x B: 233 mm				
17162	Manure plug DN300, A: 339 x B: 284 mm				
Art. No. Accessories for troughs					
02163	Polyester Glue	0,5 kg, 150 g per joint, 250 g per partition (approx. 2-3 joints)			
18435	Polyester Glue	4 kg for jointing, 150 g per joint, 250 g per partition (approx. 16-26 joints)			
18990	Joint filler	For feeding tables			
523003	Mixing point				
560308	Funki Component Fix				

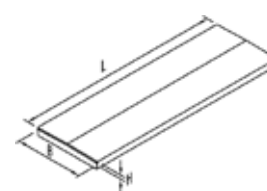
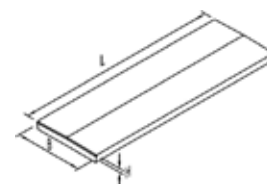

| MOUNTING SUGGESTIONS |

TS30 TROUGH AND PARTITION

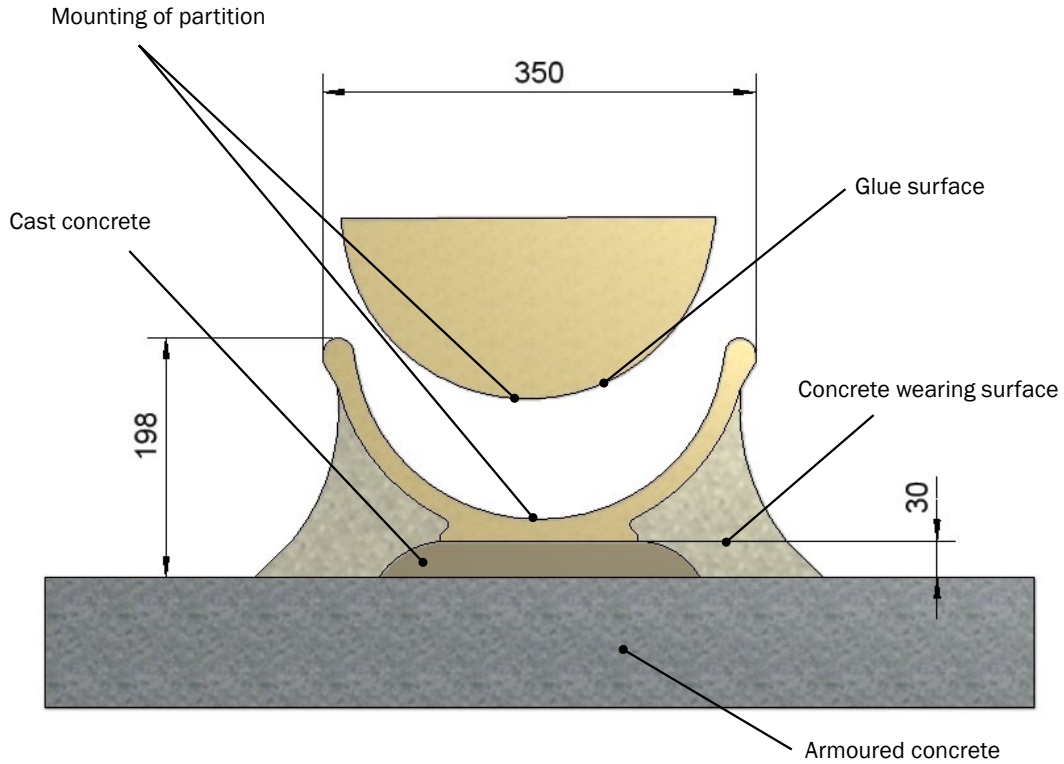

CATTLE TROUGH

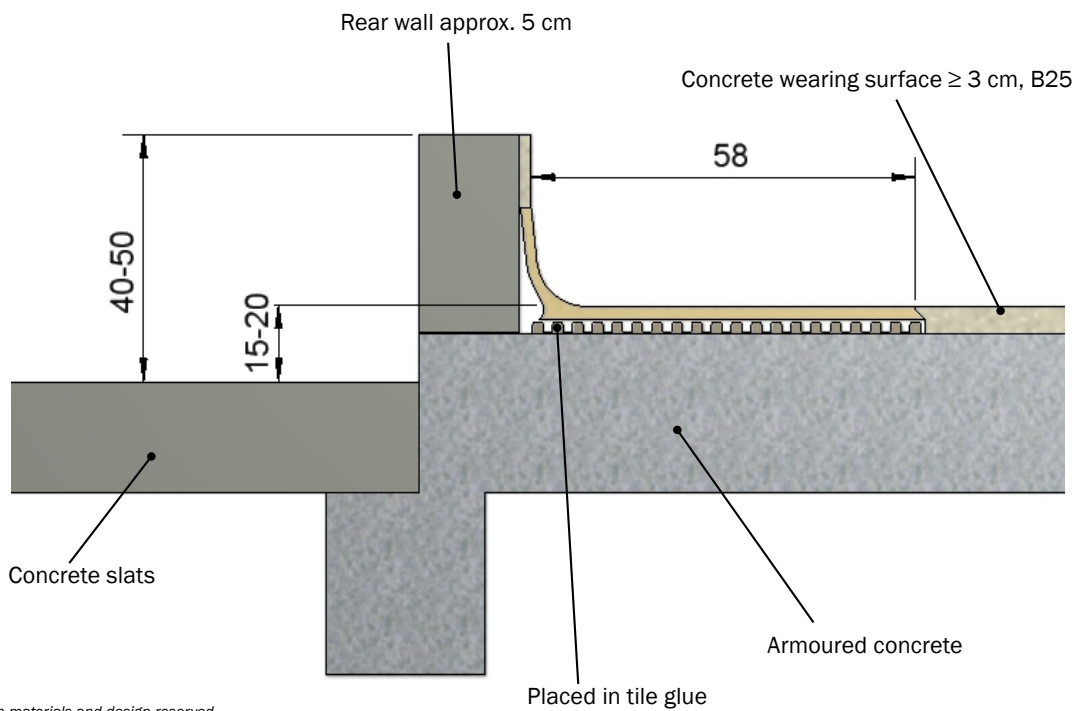

Subject to changes in materials and design reserved.

B-8014-GB